

Tracki^{4G} Pet

The smart
GPS tracker

Quick Start Guide

EN | FR | ES | DE | IT | PT | JP

Get in touch

Thank you for choosing Tracki.

Our support team is available 7 days a week to help with your queries. We are dedicated to addressing your issues as fast as possible and will always go the extra mile to ensure your satisfaction.

Contact us any day at:

e-Mail: support@tracki.com

US: +1 (323) 785 2020 (9AM-11PM EST)

UK: +44 7700 175 888 (3PM-11PM CET)

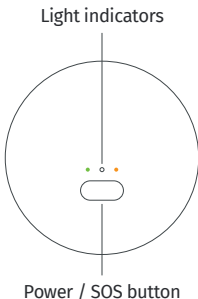

Quick start guide

Getting started

1

Scan to download, sign in to the TrackiPet app and view the full user manual



2

Charge for 2hrs before first use

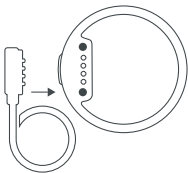

3

Take the device outdoors and start tracking

* Short-press the button to ensure the device is on. If none of the lights turn on, press the button for 5s



Buttons and lights

Device is starting up
(long press 5s)



Device is powering off
(long press 3s)



Device is online
(single press)



Device is on but offline
(single press)



Activate SOS mode
(triple press)



Battery is low
(flashes continuously)



Device is charging
(connected to power)



Device is fully charged



Guide de démarrage rapide

Contactez-nous

FR

Merci d'avoir choisi Tracki.

Notre équipe de support est disponible 7j/7 pour répondre à vos questions. Nous nous engageons à résoudre vos problèmes aussi rapidement que possible et nous nous efforcerons toujours de vous satisfaire.

Nous sommes joignables tous les jours à:

e-Mail: support@tracki.com

USA: +1 (323) 785 2020 (9H00 - 23H00 HNE)

RU: +44 7700 175 888 (3H00 - 23H00 CET)

Indicateurs lumineux

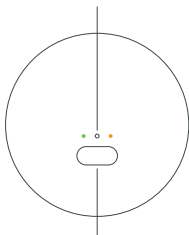

Bouton d'alimentation / SOS

Mise en marche

1

Scanner pour télécharger l'application TrackiPet et consulter le manuel d'utilisation complet



2

Chargez pendant 2 heures avant la première utilisation

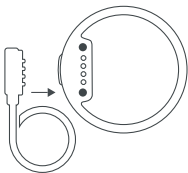

3

Appuyez sur le bouton d'alimentation et maintenez-le enfoncé pendant 3 secondes pour lancer le positionnement GPS

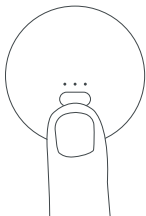

Boutons et lumières

L'appareil est mis en
marche
(pression longue)



L'appareil s'éteint
(pression longue)



L'appareil est en ligne
(Une seule pression)



L'appareil est allumé mais
hors ligne
(une seule pression)



Activer le mode SOS
(triple pression)



La batterie est faible
(clignote en continu)



L'appareil est en charge
(connecté à l'alimentation)



L'appareil est entièrement
chargé



Gracias por elegir Tracki.

Nuestro equipo de soporte está disponible los 7 días de la semana para ayudarlo con sus consultas. Estamos dedicados a abordar sus problemas lo más rápido posible y siempre haremos un esfuerzo adicional para garantizar su satisfacción.

Contáctenos cualquier día en:

e-Mail: support@tracki.com

EE. UU: +1 (323) 785 2020 (9am - 11pm EST)

Reino Unido: +44 7700 175 888 (3pm - 11pm CET)

Indicadores luminosos

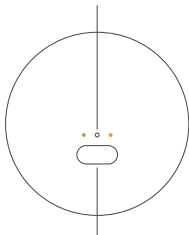

Encendido / Botón SOS

Guía de inicio rápido

Empezando

1

Escanee para descargar la aplicación TrackiPet y ver el manual de usuario completo



2

Cargue por 2 horas antes del primer uso

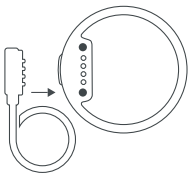

3

Mantenga presionado el botón de encendido durante 3s para iniciar el posicionamiento GPS

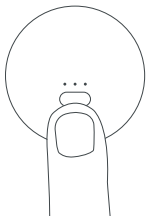

Botones y luces

El dispositivo se está
iniciando
(pulsación larga)



El dispositivo se está apagando
(pulsación larga)



El dispositivo está en línea
(presione una vez)



El dispositivo está encendido
pero fuera de línea
(presione una vez)



Activar modo SOS
(pulsación triple)



La batería está baja
(destellos continuos)



El dispositivo se está cargando
(conectado a la corriente)



El dispositivo está
completamente cargado



Danke, dass Sie sich für Tracki entschieden haben.

Unser Support-Team steht Ihnen 7 Tage die Woche zur Verfügung, um Ihnen bei Ihren Fragen zu helfen. Wir sind bestrebt, Ihre Probleme so schnell wie möglich zu lösen und werden uns stets bemühen, Ihre Zufriedenheit zu gewährleisten.

Kontaktieren Sie uns jeden Tag unter:

e-Mail: support@tracki.com

US: +1 (323) 785 2020 (9AM - 11PM EST)

UK: +44 7700 175 888 (3PM - 11PM CET)

Leuchtanzeigen

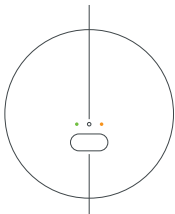

Ein-/Aus-Taste / SOS-Taste

Schnellstart-Anleitung

Erste Schritte

1

Scannen Sie, um die TrackiPet-App herunterzuladen und das vollständige Benutzerhandbuch anzuzeigen



2

Vor dem ersten Gebrauch 2 Stunden lang aufladen

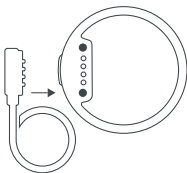

3

Halten Sie die Einschalttaste 3 Sekunden lang gedrückt, um die GPS-Ortung zu starten

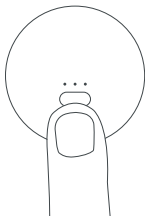

Tasten und Lichter

Gerät wird hochgefahren

(langes Drücken)



Gerät schaltet sich aus⁸

(langes Drücken)



Gerät ist online

(einmaliges Drücken)



Gerät ist eingeschaltet, aber offline

(einmaliges Drücken)



SOS-Modus aktivieren

(Dreifachpresse)



Batterie ist schwach

(flächelt ununterbrochen)



Gerät wird geladen

(an den Strom angeschlossen)



Gerät ist vollständig aufgeladen



Grazie per aver scelto Tracki.

Il nostro team di supporto è disponibile 7 giorni su 7 per aiutarti con le tue domande. Ci impegniamo ad affrontare i tuoi problemi il più rapidamente possibile e faremo sempre il possibile per garantire la tua soddisfazione.

Contattaci ogni giorno a:

e-Mail: support@tracki.com

US: +1 (323) 785 2020 (9AM - 11PM EST)

UK: +44 7700 175 888 (3PM - 11PM CET)

Segnali luminosi

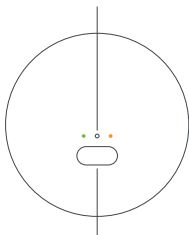

Pulsante accensione / SOS

Guida rapida

Iniziamo

1

Scansiona per scaricare
l'app TrackiPet e
visualizzare il manuale
completo



2

Carica per 2 ore
prima del primo
utilizzo

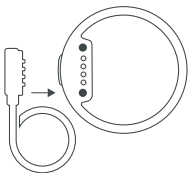

3

Tieni premuto il
pulsante di
accensione per 3
secondi per iniziare il
posizionamento GPS

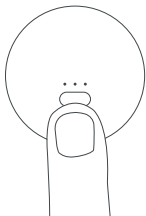

Pulsanti e luci

Il dispositivo si sta
accendendo
(premere a lungo)



Il dispositivo si sta
spegnendo
(premere a lungo)



Il dispositivo è online
(premere una volta)



Il dispositivo è acceso ma
disconnesso
(premere una volta)



Attiva modalità SOS
(premere tre volte)



La batteria è poca
(lampeggia continuamente)



Il dispositivo si sta ricaricando
(connesso alla corrente)



Il dispositivo è
completamente carico



Obrigado por escolher a Tracki.

Nossa equipe de suporte está disponível 7 dias por semana para ajudar com suas dúvidas. Nos dedicamos a resolver suas questões o mais rápido possível e trabalhar ao máximo para garantir sua satisfação.

Contacte-nos a qualquer dia através:

e-Mail: support@tracki.com

EUA: +1 (323) 785 2020 (9h-23h EST)

UK: +44 7700 175 888 (15h-23h CET)

Indicadores de luz

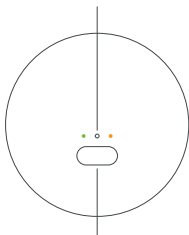

Botão de energia / SOS

Iniciando

1

Escaneie para
baixar o app
TrackiPet e acesse
o manual do
usuário completo



2

Carregue por 2
horas antes do
primeiro uso

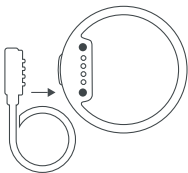

3

Pressione e segure
o botão de energia
por 3 segundos
para iniciar o
posicionamento
GPS

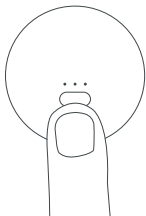

Botões e luzes

Dispositivo iniciando
(pressão longa)



Dispositivo desligando
(pressão longa)



Dispositivo online
(pressão única)



Dispositivo ligado, mas off-line
(pressão única)



Ativar SOS
(pressão tripla)



Bateria fraca
(pisca continuamente)



Dispositivo carregando
(conectado à energia)



Dispositivo carregado



Trackiをお選びいただきありがとうございます。

当社のサポートチームは、週7日、お客様のお問い合わせにお応えします。私たちはあなたの問題にできるだけ早く対処することに専念しており、常にあなたの満足を確実にするために余分なマイルを行います。

任意の日私達に連絡しなさい:

電子メール: japan@tracki.com

Line: @Tracki

ライトインジケータ

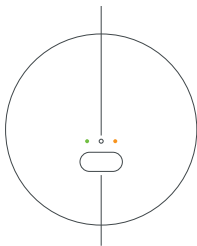

電源/SOSボタン

クイックスタートガイド はじめに

1

スキャンして
TrackiPetアプリをダ
ウンロードし、完全
なユーザーマニユア
ルを表示する



2

最初の使用前に
2時間充電して
ください

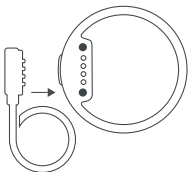

3

電源ボタンを3秒間
押し続けてGPS測位
を開始します

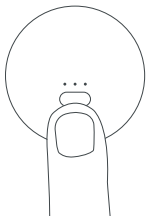

クイックスタートガイド

ボタンとライト

デバイスが起動中です
(長押し)



デバイスの電源がオフになって
います
(長押し)



デバイスがオンラインである
(1回押す)



デバイスはオンですが、オフ
ラインです
(1回押す)



SOSモードを有効にする
(3回押す)



バッテリー残量が少ない
(連続して点滅)



デバイスが充電中です
(電源に接続)



デバイスが完全に充電されて
います



Quick start guide

Changing accessories

Changement d'accessoires | Cambio de
accesorios | Wechselndes Zubehör
Cambiare accessori | Mudança de
acessórios | アクセサリーの変更

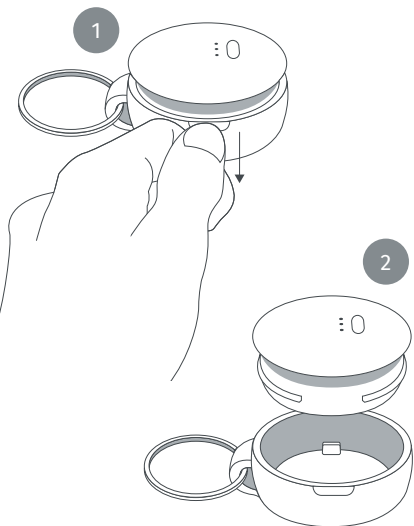

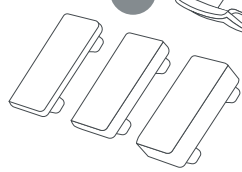
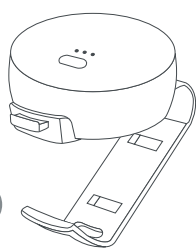
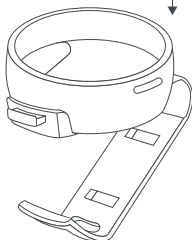
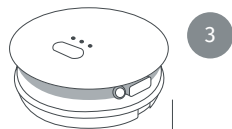

5

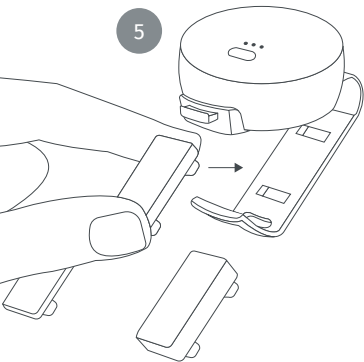

6

